

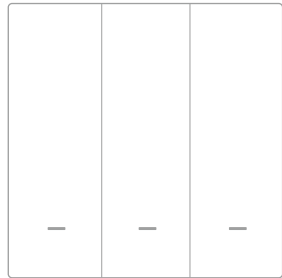

# Instruction Manual Scene Switch



English



- Bitte scannen Sie den QR-Code, um das deutsche Handbuch, das Installationsvideo und die Funktionseinführung zu erhalten
- Escanee el código QR para obtener el manual en español, el video de instalación y la introducción de la función
- Veuillez scanner le code QR pour obtenir le manuel en français, la vidéo d'installation et l'introduction des fonctions
- Отсканируйте QR-код, чтобы получить руководство на русском языке, видео по установке и описание функций
- Leia o código QR para obter o manual em português, o vídeo de instalação e a introdução das funções

02

## Product Introduction



- This Scene Switch is powered by battery, which is developed under ZigBee communication. After connecting with ZigBee gateway and adding into Smart life App, it allows you to quickly "set the scene" for a particular room or living scene, like Reading, Movie, and so on.
- Scene Switch is a time and energy-saving item alternative to the traditional hard-wired switch, with push button design it can be stick on the wall or put it on everywhere you like.

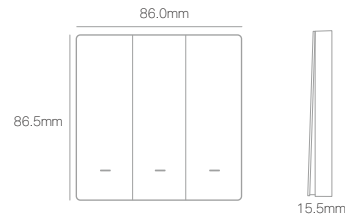

03

## Scene Switch with Your Smart Home

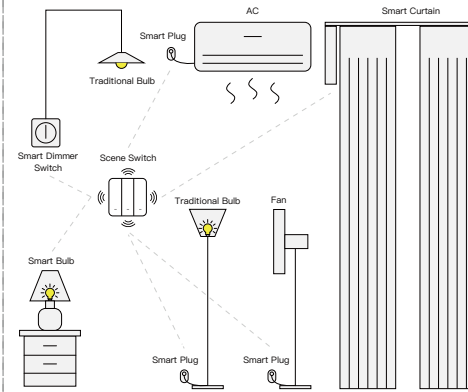

04

## Specification

Input Power:	CR 2032 button battery
Communication:	ZigBee 3.0
Dimension:	86*86.5*15.5mm
Standby current:	10uA
Working Temperature:	-10°C~45°C
Working Humidity:	<90%RH
Button lifecycle:	500K

## Installation

Open the cover then put the button battery in the battery slot. Press the button on the switch, the indicator will turn on, it means that the switch works correctly.

05

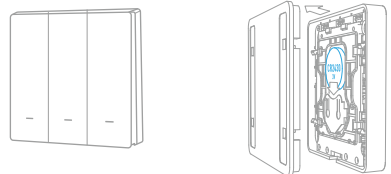

- Pry open switch backplane
- Open the cover then put the button battery in the battery slot.

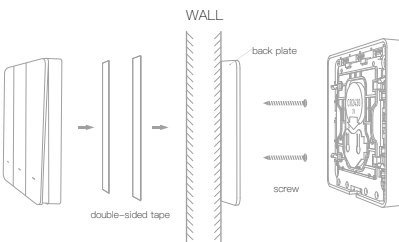

Method 1:

Clean the walls with a cloth, then blow dry them. Use double-sided tape on the back of the scene switch and then stick it on the wall

Method 2:

First remove the bottom plate of the scene switch, fix it on the wall with screws, and then cover the panel

06

## Fix it as Where as You Want



Bedroom

Living Room

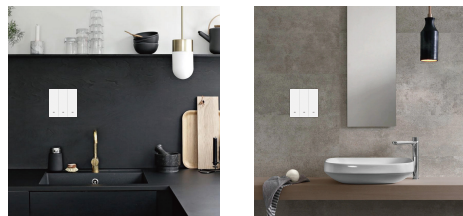

Kitchen

Bathroom

07

## Connection and Operation

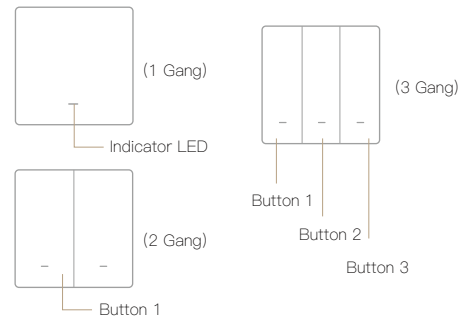

Indicator LED  
Long press the button, the indicator will turn on. The indicator flash quickly, it means that the switch under process of network connecting.  
Scene Switch Operate: Each one button can be adapted upto three different scenarios through the APP.  
(Single Click) : Activate the 1st scene  
(Double Click) : Activate the 2nd scene  
Long Hold 5s: Activate the 3rd scene  
Press and Hold button 1 for 10s get into pair mode, LEDs will quick flash

08

## APP Operation

1. Search the App in the store or scan the QR code on the package/ manual to download and install the App.



Please scan the QR code or download Smart Life on App store.

2. Register and login

If you download for the first time, please click the "register" button to register your account. If you have an account, click the "login" button.

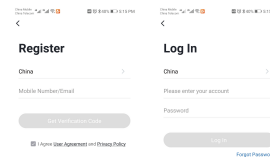

09

## APP Operation

3. Add devices

Note: ZigBee gateway needs to be added before adding devices  
Connect the device to the power supply, press and hold the first button to put the device into the network configuration mode, and ensure that the mobile phone is connected to the same network. Open the app, on the "smart gateway" page, click "add subdevice", and click "LED already blink".

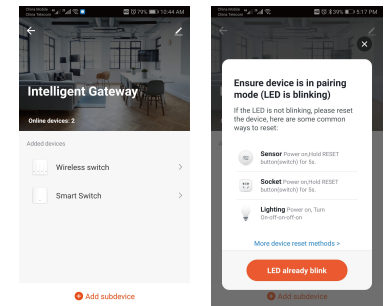

10

## APP Operation

Wait for device networking to succeed, Click "DONE" to add the device successfully.  
 \*NOTE: If you fail to add the device, please move the gateway closer to the product and reconnect the network after powering on.

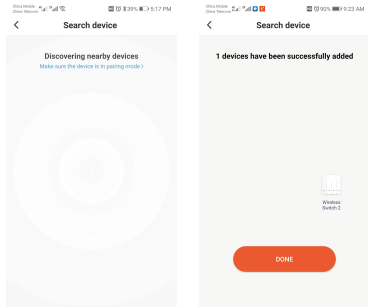

11

## APP Operation

After connecting the network successfully, you will see the Intelligent Gateway page, choose the WIRELESS SWITCH 2 to enter the controlling page, then choose "Add intelligence" to enter to the setting mode.

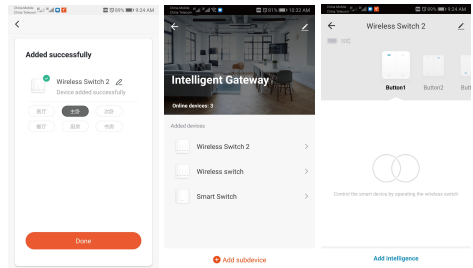

12

## APP Operation

Choose "Add condition" to choose the controlling condition, such as "Single click", the choose "Add task" choose the controlling action.

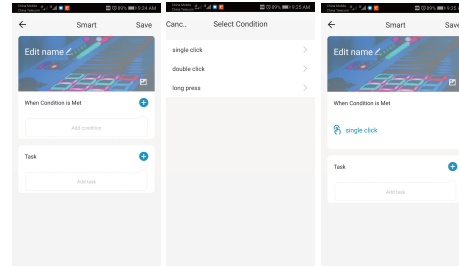

13

## APP Operation

Such as choose the On/Off status of the switch.

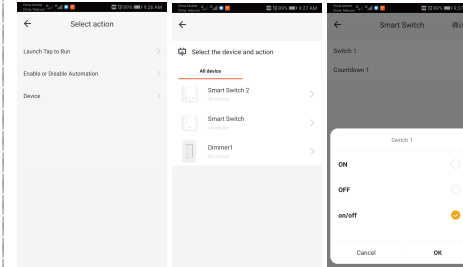

14

## APP Operation

Save your collocation, the you could use the scene switch to control the light.

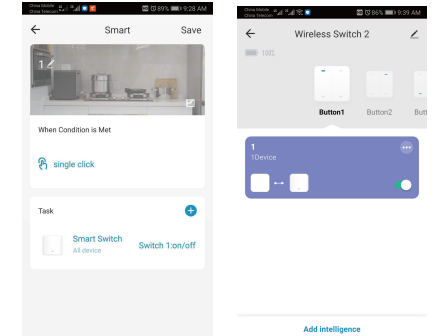

15

## SERVICE

1. During the free warranty period, if the product breaks down during normal use, we will offer free maintenance for the product.
  2. Natural disasters/man-made equipment failures, disassembly and repair without the permission of our company, no warranty card, products beyond the free warranty period, etc., are not within the scope of free warranty.
  3. Any commitment (oral or written) made by the third party (including the dealer/service provider) to the user beyond the warranty scope shall be executed by the third party.
  4. Please keep this warranty card to ensure your rights.
  5. Our company may update or change the products without notice.
- Please refer to the official website for the updates.

16

## RECYCLING INFORMATION

All products marked with the symbol for separate collection of waste electrical and electronic equipment (WEEE Directive 2012 /19 / EU) must be disposed of separately from unsorted municipal waste. To protect your health and the environment, this equipment must be disposed of at designated collection points for electrical and electronic equipment designated by the government or local authorities. Correct disposal and recycling will help prevent potential negative consequences for the environment and human health. To find out where these collection points are and how they work, contact the installer or your local authority.



17

## WARRANTY CARD

### Product Information

Product Name \_\_\_\_\_  
 Product Type \_\_\_\_\_  
 Purchase date \_\_\_\_\_  
 Warranty Period \_\_\_\_\_  
 Dealer Information \_\_\_\_\_  
 Customer's Name \_\_\_\_\_  
 Customer Phone \_\_\_\_\_  
 Customer Address \_\_\_\_\_

### Maintenance Records

Failure date	Cause Of Issue	Fault Content	Principal

18

AL23  
19

20